

ZOSI

Wireless indoor base station system user manual

Plug and play,add device to APP by scanning QR code.

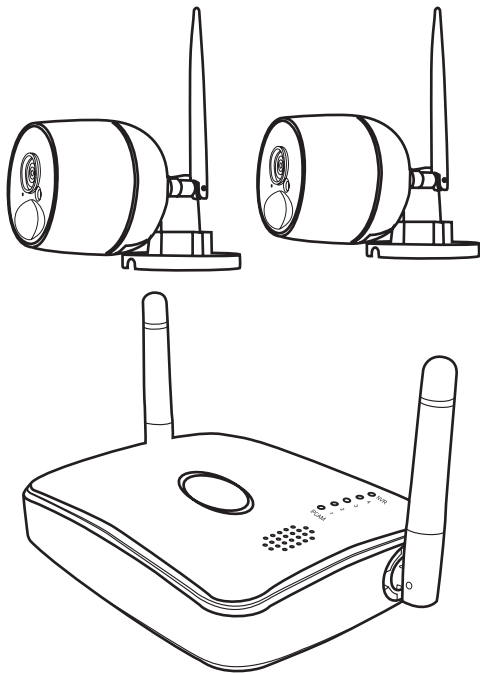

Before using the product,please read the quick guide carefully and keep the manual properly.

List of products (please refer to the material item)

After undo the package, please check whether the camera is in good condition, and confirm whether the accessories are complete according to the below pictures.

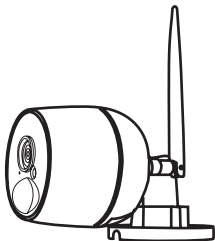

IPC*2

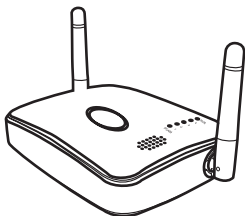

NVR*1

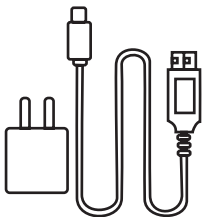

Power supply*3



Quick guide*1

Product description (pictures are for reference only, please refer to the actual object)

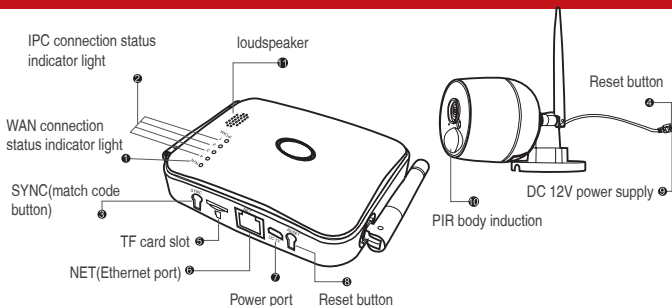

Description and explanation

1. WAN(Wide Area Network) connection status indicator light

When LAN is connected or the WAN is disconnected, the indicator light will flash slowly. When WAN is connected successfully, the indicator light keeps on.

2. IPC connection status indicator light

When the IPC is connected to MINI NVR, the light keeps on, and flash slowly when disconnected.

3. SYNC(match code button)

Long press the button for 4 seconds to enter the code state, you can hear the voice prompt "matching code started, please wait for voice prompt to complete", then you get the voice prompt of "matching code successfully" or "matching code failed".

4. IPC(match code method)

Long press the reset key of the two IPC for 5 seconds, then the cameras will restore to the factory default settings, the IPC tail light will flash. Then long press the MINI NVR match code key for 4 seconds, wait the voice prompt of "matching code successfully", and check if the MINI NVR indicator light and IPC tail light are keeping on, if yes, it means the matching code successfully. (Please note, the IPC matching code was accomplished before it leaves the factory, plug and play, you don't need to match code at the first time. If you need to change or add more IPC, please refer to the above instruction and add the new IPC by matching code.)

5. TF card slot

The system defaults to motion detection recording after inserting a TF card.

6. NET

Network cable interface router

7. DC 5V power port

8. RESET long press 10 seconds to reset

9. DC 12V power port

10. PIR body induction PIR body motion detection

11. Loudspeaker built-in speaker, audio broadcast

Operation tips

Download the monitoring software app to your phone by scanning the below QR codes.



App store



Google play

User registration

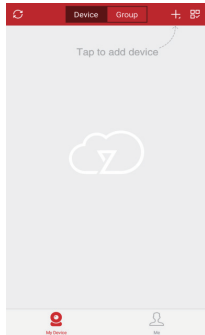
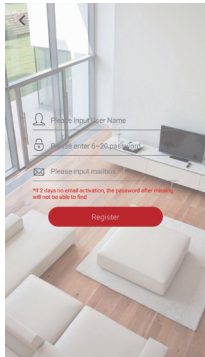
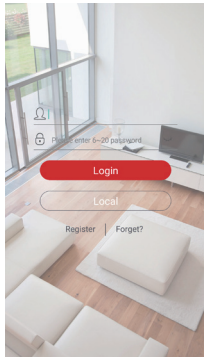

Add device

Step 1: Power on the IPC and MINI NVR, and connect the MINI NVR to the router by network cable.

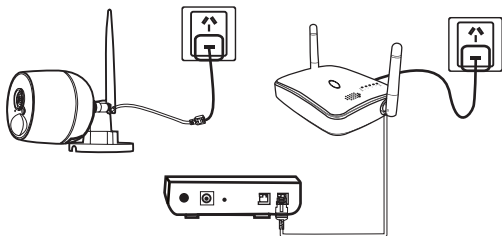

Step 2: Connect your phone to the same WiFi of the router.

Step 3: Open zosicloud and login, then click "+" in the top right corner.

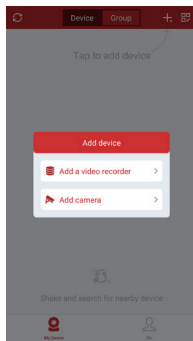
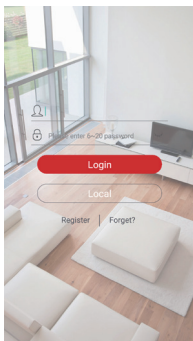

Step 4: Add the device by scanning the QR code on the MINI NVR manually, then submit it.

< Add device Submit

Cloud ID 1374666454

Descriptions My Device1

User Name admin

Password

Step 5: Tap the channel number to connect the camera or “playback” to view the footage remotely.

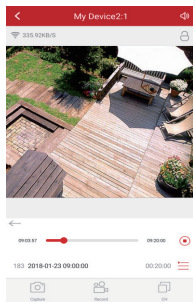
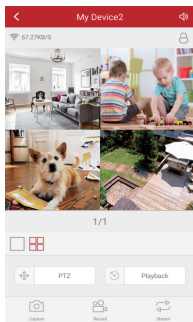
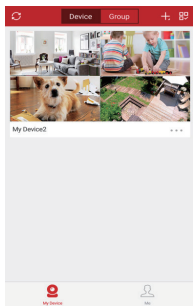

ZOSI

PROFESSIONAL SECURITY MADE EASY

www.zositech.com

service@zositech.com

All rights reserved. No part of this publication may be reproduced by any means without written permission from ZOSI. The information in this publication is believed to be accurate in all respects.

ZOSI cannot assume responsibility for any consequences resulting from the use thereof. The information contained herein is subject to change without notice. Revisions or new editions to this publication may be issued to incorporate such changes.



PACKAGING

